

FEATURES & SPECIFICATIONS

INTENDED USE — Typical applications include corridors, lobbies, conference rooms and private offices.
CONSTRUCTION — Retrofit, remodel, and new construction mounting types. See table for compatible ceiling openings and thickness range.

1/2"-1-1/2" ceiling thickness

25° ambient temperature

New construction frame accessories approved for 8 (4 in/4 out) No. 12 AWG conductors rated for 90°C through wiring.

OPTICS — LEDs are binned to a 3-step Mac Adam Ellipse. 55° cutoff
 80CRI standard (90CRI optional)

UGR — UGR is zero for fixtures aimed at nadir with a cut-off equal to or less than 60deg, per CIE 117-1996 Discomfort Glare in Interior Lighting. [UGR FAQ](#)

ELECTRICAL — Adjustable lumen output with four module options. Fixed lumen options also available. MVOLT 120/277V 50/60Hz driver (0-10V & 120V Phase Dimming to 10% or 1% min dimming level)
 FCC CFR Title 47 Part 15 Class A for 277V. FCC CFR Title 47 Part 15 Class B for 120V.

LUMEN MAINTENANCE — L80 at 60,000 hours

LISTINGS — Certified to US and Canadian safety standards. Damp location standard (Wet Location (WL) optional, requires covered ceiling). Some configurations are ENERGY STAR® certified, please visit www.energystar.gov for specific products. TAA compliant. IP55 rated (WL and AT options only). Drivers are ROHS compliant.

WARRANTY — 5-year limited warranty. This is the only warranty provided and no other statements in this specification sheet create any warranty of any kind. All other express and implied warranties are disclaimed. Complete warranty terms located at: www.acuitybrands.com/support/warranty/terms-and-conditions

Note: Actual performance may differ as a result of end-user environment and application. All values are design or typical values, measured under laboratory conditions at 25 °C. Specifications subject to change without notice.

Catalog Number
Notes
Type

LBR4 Square

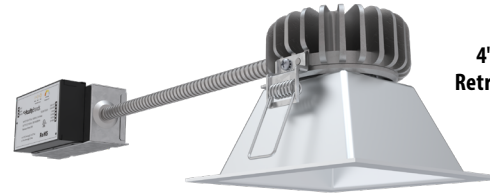

4" Open and Wallwash LED Retrofit/Remodel Downlight

Retrofit | Remodel

Performance Data

LBR4SQ AR LSS MWD		80CRI							
Lumen Output	Wattage	30K/80CRI		35K/80CRI		40K/80CRI		50K/80CRI	
		Delivered Lumens	LPW	Delivered Lumens	LPW	Delivered Lumens	LPW	Delivered Lumens	LPW
AL01 (500LM)	6	492	85	503	87	515	88	531	90
AL01 (750LM)	9	778	88	796	89	815	91	840	93
AL01 (1000LM)	13	1093	85	1118	86	1145	88	1180	90
AL02 (1000LM)	13	1158	93	1185	95	1213	97	1251	99
AL02 (1500LM)	19	1691	90	1730	92	1771	93	1826	96
AL02 (2000LM)	25	2130	86	2179	87	2231	89	2300	91
AL03 (2000LM)	25	2191	89	2242	90	2295	92	2366	94
AL03 (2500LM)	32	2645	84	2707	86	2771	87	2857	89
AL03 (3000LM)	38	3004	80	3074	81	3147	83	3244	85
AL04 (4000LM)	39	3486	90	3557	92	3628	94	3664	95
AL04 (4500LM)	44	3847	88	3926	89	4004	91	4044	92
AL04 (5000LM)	49	4184	85	4269	87	4355	88	4397	89

LBR4SQ AR LSS WD		80CRI							
Lumen Output	Wattage	30K/80CRI		35K/80CRI		40K/80CRI		50K/80CRI	
		Delivered Lumens	LPW	Delivered Lumens	LPW	Delivered Lumens	LPW	Delivered Lumens	LPW
AL01 (500LM)	6	441	76	450	78	459	79	463	80
AL01 (750LM)	9	698	78	712	80	726	81	733	82
AL01 (1000LM)	13	980	75	1000	77	1020	79	1030	79
AL02 (1000LM)	13	1039	83	1060	85	1081	86	1092	87
AL02 (1500LM)	19	1516	80	1547	82	1578	84	1593	84
AL02 (2000LM)	25	1910	76	1949	78	1988	79	2007	80
AL03 (2000LM)	25	1965	79	2005	81	2045	82	2065	83
AL03 (2500LM)	32	2372	75	2420	77	2469	78	2493	79
AL03 (3000LM)	38	2694	71	2749	73	2804	74	2831	75
AL04 (4000LM)	39	3189	82	3254	84	3319	86	3352	87
AL04 (4500LM)	44	3520	80	3591	82	3663	83	3699	84
AL04 (5000LM)	49	3827	78	3906	79	3984	81	4023	82

- Tested in accordance with IESNA LM-79-08. u8226
- Tested to current IES and NEMA standards under stabilized laboratory conditions.
- CRI: 80 typical



battery pack

LBR4SQ

Module ordering

ORDERING INFORMATION

Lead times will vary depending on options selected. Consult with your sales representative.

Example: LBR4SQ ALO2 SWW1 AR LSS MWD MVOLT UGZ 90CRI

Series	Lumens ‡	Color temperature ‡	Reflector Color	Reflector Flange ‡	Reflector Finish
LBR4SQ 4" Square Retrofit	Adjustable Lumen Output	Switchable CCT	AR	(blank)	LSS
LBR4SQWW ‡ 4" Square Retrofit Wallwash	ALO1 500/750/1000lm ALO2 1000/1500/2000lm ALO3 2000/2500/3000lm ALO4 4000/4500/5000lm	SWW1 3000K-3500K-4000K-5000K Fixed CCT 27K 2700K 30K 3000K 35K 3500K 40K 4000K 50K 5000K	Clear BR ‡ Black painted WR ‡ White painted TCPC ‡ Custom painted trim TRALTBD ‡ RAL painted trim	Self-flanged TRW White painted flange TRBL Black painted flange FCPC Custom painted flange only FRALTBD RAL painted flange only	Semi-specular
	Fixed Lumen Output				
	05LM 500lm 07LM 750lm 10LM 1000lm 15LM 1500lm 20LM 2000lm 25LM 2500lm 30LM 3000lm 40LM 4000lm 45LM 4500lm 50LM 5000lm				

Distribution	Voltage	Driver	Emergency ‡	Control Input ‡
MWD Medium wide (1.0 s/mh)	MVOLT 120	UGZ Universal dimming to 10% 0-10V; line voltage dimming (120V)	(blank) No Emergency Needed	(blank) No Control Input Needed
WD Wide (1.2s/mh)	277	UGZ1 Universal dimming to 1% 0-10V; line voltage dimming (120V)	ELR Battery pack (10W constant power) Non-T20 Compliant remote test switch	JOT Wireless room control with "Just One Touch" pairing
WW ‡ Wallwash	347	DALI ‡ DALI dimming to 1% D10 Minimum dimming 10% driver for use with JOT D1 Minimum dimming 1% driver for use with JOT	ETS Iota Emergency Transfer System E10WCP Battery pack (10W constant power) Non-T20 Compliant integral test switch E10WCPR Battery pack (10W constant power) T20 Compliant remote test switch E10WRSTAR Emergency battery pack, 10W with remote test switch and Iota STAR technology	NPS80EZ nLight® network power/relay pack with 0-10V dimming NPS80EZER nLight® network power/relay pack with 0-10V dimming; ER controls fixtures on emergency circuit. NLTAIR2 nLight® Air enabled NLTAIRER2 nLight® AIR Dimming Pack Wireless Controls. Controls fixtures on emergency circuit NLTAIREM2 nLight® AIR Dimming Pack Wireless Controls. UL924 Emergency Operation, via power interrupt detection.

Options

- 90CRI High CRI (90+)
- AT ‡ Airtight
- EC1 ‡ Extended Conduit (18")
- EC6 ‡ Extended Conduit (6ft)
- WL ‡ Wet Location (IP55)
- QDS ‡ Quick disconnect plugs
- CP ‡ Chicago Plenum

NOTE: ‡ indicates option value has ordering restrictions. Please reference the Option Value Ordering Restrictions chart below.

‡ Option Value Ordering Restrictions

Options	Restriction
Adjustable Lumens/CCT	Adjustable Lumen Output and Switchable CCT must be specified together (for example: ALO1 SWW1)
Fixed Lumens/CCT	Fixed Lumen Output and Fixed CCT must be specified together (for example: 10LM 30K)
AT	Standard for CP and IP55, not available with WW
E10WCPR	Not available EC1, EC6, QDS, CP, 347V, NPS80EZ ER, NLTAIRER2, NLTAIREM2, ALO3 & ALO4 w/DALI, OR 2000-4500 lumens w/JOT.
E10WCP	Not available with EC1, EC6, AT, QDS, CP, 347V, NPS80EZ ER, NLTAIRER2, NLTAIREM2, WL, ALO3 & ALO4 w/DALI, OR 2000-4500 lumens w/JOT.
E10WRSTAR	Not available with wet location, EC1, EC6, QDS, CP, 347V, NPS80EZ ER, NLTAIRER2, NLTAIREM2, ALO3 & ALO4 w/DALI, OR 2000-4500 lumens w/JOT. Top access installation or 17.5" plenum clearance required for roomside installation. Not available with integral test switch
ELR	Not available EC1, EC6, QDS, CP, 347V, NPS80EZ ER, NLTAIRER2, NLTAIREM2, ALO3 & ALO4 w/DALI, OR 2000-4500 lumens w/JOT.
EC1, EC6	Not Available with CP, QDS, ELR, E10WCP, or E10WCPR.
WL	Not available with WW, All CP is wet location, except WW (Damp). IP55 rated.
QDS	Must be specified for use with LBR_PFWQDS. Not available with 347V, CP, QDS, ELR, E10WCP, E10WCPR.
JOT	Not available with CP, nLight options, UGZ, or DALI drivers. Max 4500 lumens. Fixed lumens and CCT only. Not available with 2000-4500lm in conjunction with battery pack.
NPS80EZ	Not available with CP, QDS, DALI, D1, OR D10 drivers. 120V OR 277V only. Not available with 347V.
NPS80EZER	Not available with CP, QDS, ELR, E10WCP, E10WCPR, DALI, D1, OR D10 drivers. 120V OR 277V only. Not available with 347V.
NLTAIR2	Not available with CP, QDS, DALI, D1, OR D10 drivers. See UL 924 Sequence of Operation table. Non-emergency luminaires with this option can be used as a normal power sensing device for nLight AIR devices and luminaires with EM emergency options.
NLTAIRER2	Not available with CP, QDS, ELR, E10WCP, E10WCPR, DALI, D1, OR D10 drivers. Not available with 347V.
NLTAIREM2	Not available with CP, QDS, ELR, E10WCP, E10WCPR, DALI, D1, OR D10 drivers. See UL 924 Sequence of Operation table.
ETS	Not available with, QDS, ELR, E10WCP, E10WCPR, 347V, JOT, NPS80EZ, NPS80EZ ER, NLTAIRER2, NLTAIREM2, DALI, D1, OR D10 driver
DALI	Not available with fixed lumens or CCT. Max 4500 lumens.
WW	Not available with WL, ELR, E10WCP, and E10WCPR. Must be ordered with LBR4SQWW series
TRW, TRBL	Available with MS and AR reflectors only.
MS, WR, BR	Not available with LSS reflector finish
LBR 347V	Not available with CP, QDS, ELR, E10WCP, E10WCPR, NLTAIRER2, ETS, NPS80EZ, OR NPS80EZER,
TRALTBD, FRALTBD	RALTBD for pricing only. Replace with applicable RAL number and finish when ready to order. See the RAL BROCHURE for available color options.
TCPC, FCPC	CPC options for pricing only. Custom color chip needs to be sent in to your Customer Resolution specialist before order can be processed. Click HERE for more details

LBR4SQ

Accessories: Order as separate catalog number. Shipped separately.	
LBR46 SQFPAN U	Mounting plate 4"-8" unit pack
LBR46 SQFPAN J10	Mounting plate 4"-8" 10-pack
LBR SDT 347V 75W ASM	Field installed 347V Step-down transformer

Fixture	Plaster Frame Accessory	Compatible Mounting Option
LBR4SQ, LBR4SQWW	LBR4SQPF	QDS, EC1, ELR, E10WCPR
	LBR4SQPFW	Base fixture only
	LBR4SQPFWQDS	QDS fixture only

Emergency Battery Pack Options - Field Installable

Battery Model Number	Wattage	Runtime (Minutes)	Lumen Output* @ 120 Lumens/Watt	Other
ILB CP07 2H A	7W	120	840	Storm Shelter / 2 Hour Runtime
ILB CP10 A	10W	90	1200	
ILBLP CP10 HE SD A+	10W	90	1200	Title 20, Self Diagnostic
ILBLP CP15 HE SD A+	15W	90	1800	Title 20, Self Diagnostic
ILB CP20 HE A	20W	90	2400	Title 20
ILB CP20 HE SD A	20W	90	2400	Title 20, Self Diagnostic
ILBHI CP10 HE SD A+	10W	90	1200	347-480V AC Input, Title 20, Self Diagnostic
ILBHI CP15 HE SD A+	15W	90	1800	347-480V AC Input, Title 20, Self Diagnostic

All the above are UL Listed products that are certified for field install external/remote to the fixture.
 *Minimum delivered lumen output to assist in product selection for increased fixture mounting height.
 The CP10 delivered emergency illumination outperforms legacy 1400 lumen fluorescent emergency ballast.
 Please contact us at techsupport@iotaengineering.com for any Emergency Battery related questions.

LBR4SQ

PLENUM DEPTH TABLE				
Aperture Size/Output	Plenum Depth*	IC	Non-IC	Non-IC Marked Spacing
LBR4SQ 500-1000 Lumen	3.44	X		
LBR4SQ 1000-2000 Lumen	3.44		X	18x18x6
LBR4SQ 2000-3000 Lumen	-			24x24x9
LBR4SQ 4000-5000 Lumen	-			24x24x9

CEILING COVERAGE TABLE						
Series		Aperture	Trim Flange OD	Min ceiling opening	Ceiling Thickness	Max ceiling opening
LBR4	SQUARE	4-1/4"	5-7/16"	4-1/2"	1/2"-1-1/2"	5-1/8"

* All dimensions are inches (millimeters) unless otherwise noted.

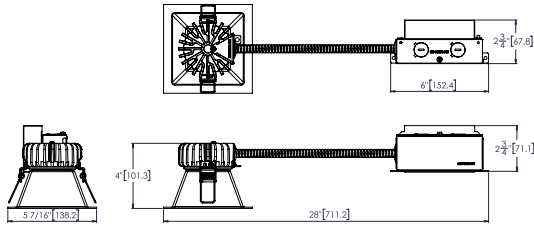

LBR4SQ SWW1 AL01/2 xx xxx MVOLT DALI

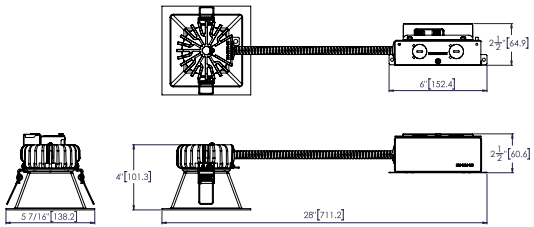
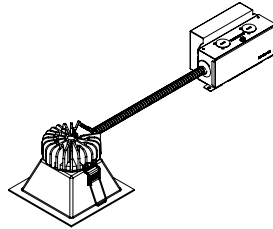

LBR4SQ SWW1 AL0x xx xxx MVOLT UGZ

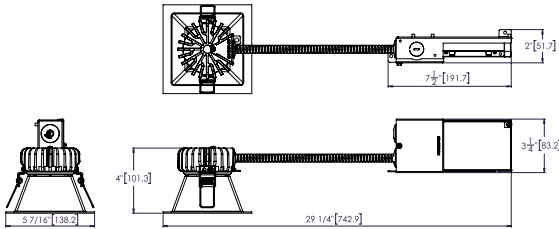
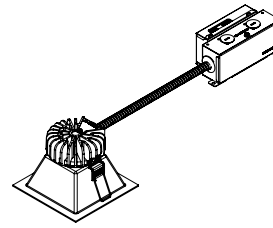

LBR4SQ SWW1 AL03 xx xxx MVOLT DALI

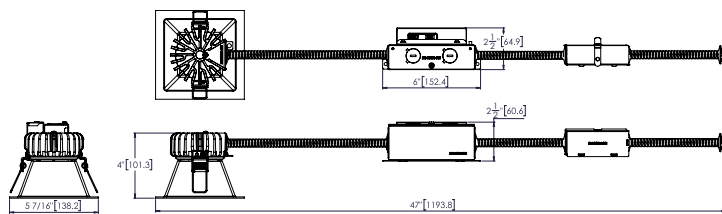
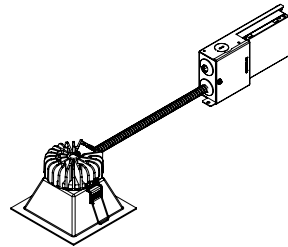

LBR4SQ SWW1 AL0x xxx MVOLT UGZ QDS

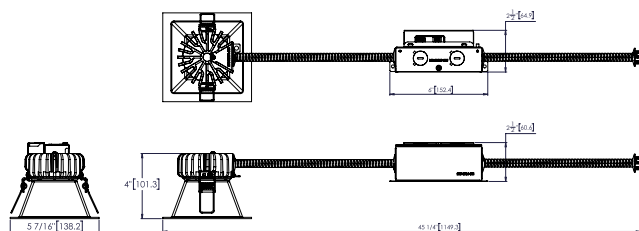
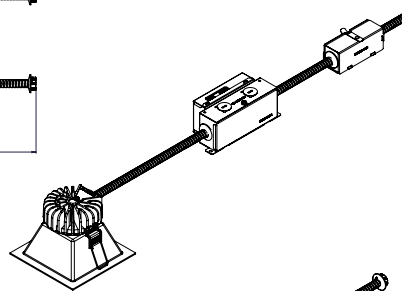

LBR4SQ SWW1 AL0x xxx MVOLT UGZ EC1

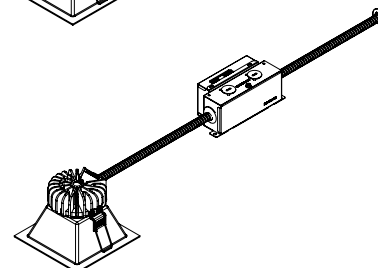

LBR4SQ

* All dimensions are inches (millimeters) unless otherwise noted.

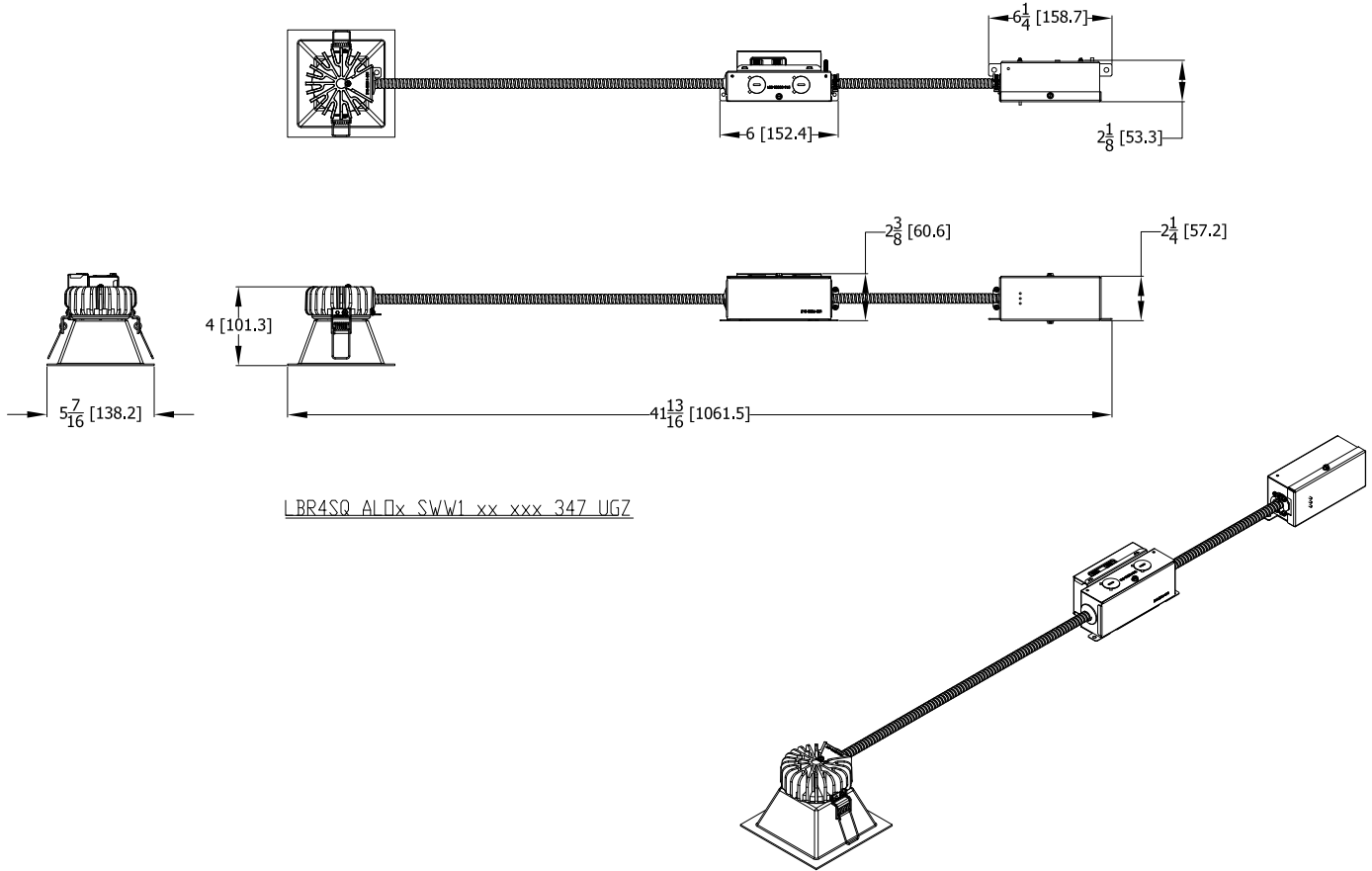

LBR4SQ AL□x SWW1 xx xxx 347 UGZ

LBR4SQ

PHOTOMETRY

Distribution Curve

Distribution Data

Output Data

Illuminance Data at 30" Above Floor for a Single Luminaire

LBR4SQ SWW1 ALO2 AR LSS MWD 1500L 35K, Input Watts: 18.6, Delivered Lumens: 1672, LPW: 89.9, S/MH: 1.11, Test No: 20-667-1

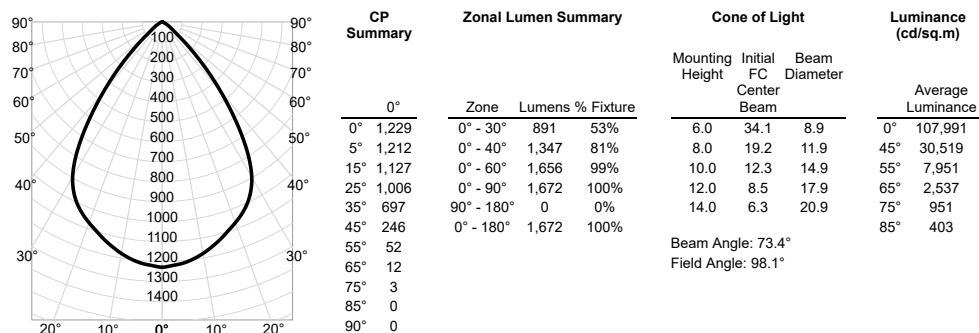

LBR4SQWW SWW1 ALO2 AR LSS WW MVOLT UGZ, Input Watts: 18.7, Delivered Lumens: 1660, LPW: 88.8, S/MH: 1.19, Test No: 20-526

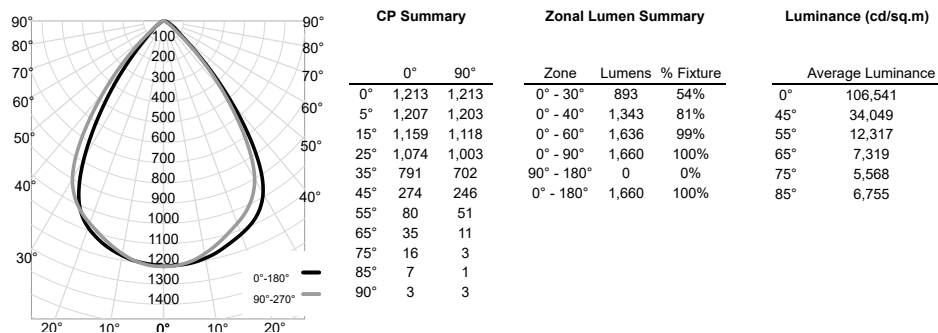

LUMEN OUTPUT MULTIPLIERS - CCT			
3000K	3500K	4000K	5000K
0.98	1.0	1.01	1.03

LUMEN OUTPUT MULTIPLIERS - FINISH	
Clear Semi-spec (AR LSS)	1.0
Metallic Silver (MS)	0.84
White Painted (WR)	1.03
Black Painted (BR)	0.60

LUMEN OUTPUT MULTIPLIERS - CRI	
80	1.0
90	0.874

HOW TO ESTIMATE DELIVERED LUMENS IN EMERGENCY MODE

Use the formula below to estimate the delivered lumens in emergency mode

$$\text{Delivered Lumens} = 1.25 \times P \times \text{LPW}$$

P = Output power of emergency driver. P = 10W for PS1055CP

LPW = Lumen per watt rating of the luminaire. This information is available on the ABL luminaire spec sheet.

The LPW rating is also available at Designlight Consortium.

DIMMER COMPATIBILITY

Not compatible with DALI or DMX dimmers. For specific compatible dimmers see below.

LINE VOLTAGE DIMMING:						
Type	Forward Phase	ALO1 (500-1000lm)	ALO2 (1000-2000lm)	ALO3 (2000-3000lm)	ALO4 (3000-5000lm)	Comment
MLV	Sensorswitch WPD	YES	YES	YES	YES	
MLV	Sensorswitch CMR PDT10 ADC VLP	YES	YES	YES	YES	
MLV	Synergy ISD 600LV	YES, 2x *	YES	YES	YES	* min 2 fixtures
INC	Synergy ISD 600 I	YES, 2x *	YES	YES	YES	* min 2 fixtures
MLV	Lutron Glyder GLV-600	YES	YES	YES	YES	
INC	Leviton SureSlide 6633	YES	YES	YES	YES	
MLV	Lutron Diva DVLV-600P	YES	YES	YES	YES	
MLV	Lutron Skylark SLV-600P	YES	YES	YES	YES	
INC	Lutron RadioRA 2 10ND	YES	YES	YES	YES	
MLV	Leviton SureSlide 6613-PLW	YES	YES	YES	YES	
INC	Lutron Diva DVCL-153P	YES	YES	YES	YES	
MLV	Leviton IPM06	YES, 2x *	YES	YES	YES	* min 2 fixtures
INC	Leviton IPI06	YES, 2x *	YES	YES	YES	* min 2 fixtures
INC	Control4 C4-FPD 120	YES	YES	YES	YES	
Type	Reverse Phase Dimmer Bank	ALO1 (500-1000lm)	ALO2 (1000-2000lm)	ALO3 (2000-3000lm)	ALO4 (3000-5000lm)	
ELV	Lutron Nova T NTELV-600	YES	YES	YES	YES	
ELV	Lutron Diva DVELV 600P	YES	YES	YES	YES	
ELV	Lutron Maestro MAELV 600	YES	YES	YES	YES	
ELV	Leviton Vizia VPE06-1LX	YES	YES	YES	YES	
ELV	Leviton Illumatech IPE04	YES	YES	YES	YES	
ELV	Control4 C4-APD 120 REVERSE PHASE	YES	YES	YES	YES	
Type	Miscellaneous Dimmers	ALO1 (500-1000lm)	ALO2 (1000-2000lm)	ALO3 (2000-3000lm)	ALO4 (3000-5000lm)	
PHA	Lutron RadioRA2 RRD-6NA	YES	YES	YES	YES	
PHA	Lutron Maestro PRO LED+ RRD-PRO	YES	YES	YES	YES	
Type	Control Systems	ALO1 (500-1000lm)	ALO2 (1000-2000lm)	ALO3 (2000-3000lm)	ALO4 (3000-5000lm)	
MLV	Lutron LP-RPM-4U	YES	YES	YES	YES	
PHA	Lutron LP-RPM-4A	YES	YES	YES	YES	
MLV	Lutron GRAPHIC EYE QSGRJ-3P	YES	YES	YES	YES	
PHA	Lutron PA Power Module PPHM-PA-120	YES	YES	YES	YES	
ELV	Lutron nLight nSP5PCD ELV	YES	YES	YES	YES	

DIMMER COMPATIBILITY

Not compatible with DALI or DMX dimmers. For specific compatible dimmers see below.

0-10V DIMMING:							
Manufacturer	System Type	Description	P/N	ALO1 (500-1000lm)	ALO2 (1000-2000lm)	ALO3 (2000-3000lm)	ALO4 (3000-5000lm)
ACUITY	Wall Box	sensorswitch, dimming switch with multi-way option	SPODMRA	YES	YES	YES	YES
ACUITY	Wall Box	sensorswitch, wall switch sensor, occupancy controlled dimming	WSX D WH	YES	YES	YES	YES
ACUITY	Control System	nLight	nPP16D	YES	YES	YES	YES
ACUITY	Control System	nLight	nPS 80 EZ	YES	YES	YES	YES
ACUITY	Control System	nLight Air	rPP20 D	YES	YES	YES	YES
Lutron	Other	0-10V (sink or source) PowPak wireless dimming module	RMJ-5T-DV-B	YES	YES	YES	YES
Wattstopper	Control System	Digital single relay room controller (0-10V)	LMRC-211	YES	YES	YES	YES
Crestron	Control System	DIN Rail 0-10V fluorescent dimmer, 4 feeds, 4 channels (Green Light System)	DIN-4DIMFLV4	YES	YES	YES	YES
Lutron	Other	Grafik Eye 0-10V adapter	GRX-TVI	YES	YES	YES	YES
Leviton	Wall Box	Illumatech 0-10V	IP710-DLX	YES	YES	YES	YES
Lutron	Control System	Mounted in the Homeworks QS panel - 0-10V dimmer (sink or source)	GRX-TVM2	YES	YES	YES	YES
Lutron	Wall Box	Nova 0-10V wallbox dimmer (use with PP-120-H line voltage relay)	NFTTV	YES	YES	YES	YES
Lutron	Wall Box	Nova 0-10V wallbox dimmer (use with PP-120-H line voltage relay)	NTSTV-DV	YES	YES	YES	YES
Lutron	Wall Box	Nova T	NFTV	YES	YES	YES	YES
Leviton	Wall Box	Renior II 0-10V	AWSMG-7DW	YES	YES	YES	YES

ADDITIONAL DATA



The Sensor Switch JOT enabled solution offers a wireless, app-free approach to single room lighting control. JOT enabled products use Bluetooth® Low Energy (BLE) technology to enable wireless dimming and switching.

Diagram



LBR4SQ Series



Sensor Switch
WSXA JOT

1. **Power:** Install JOT enabled fixtures and controls as instructed.
2. **Pair:** Insert the pairing tool into the pinhole on the wall switch; press and hold any button for 6 seconds.
3. **Play:** Once paired, each fixture will individually dim down to 10% brightness. All products will be fully functional.

COMPATIBLE 0-10V WALL-MOUNT DIMMERS

MANUFACTURER	PART NO.	POWER BOOSTER AVAILABLE
Lutron®	Diva® DVTV	
	Diva® DVSCTV	
	Nova T® NTFTV	
	Nova® NFTV	
Leviton®	AWSMT-7DW	CN100
	AWSMG-7DW	PE300
	AMRMG-7DW	
	Leviton Centura Fluorescent Control System	
	IllumaTech® IP7 Series	
Synergy®	ISD BC	RDMFC
	SLD LPCS	
	Digital Equinox (DEQ BC)	
Douglas Lighting Controls	WPC-5721	
Entertainment Technology	Tap Glide TG600FAM120 (120V)	
	Tap Glide Heatsink TGH1500FAM120 (120V)	
	Oasis OA2000FAMU	
Honeywell	EL7315A1019	EL7305A1010 (optional)
	EL7315A1009	
HUNT Dimming	Preset slide: PS-010-IV and PS-010-WH	
	Preset slide: PS-010-3W-IV and PS-010-3W-WH	
	Preset slide, controls FD-010: PS-IFC-010-IV and PS-IFC-010-WH-120/277V	
	Preset slide, controls FD-010: PS-IFC-010-3W-IV and PS-IFC-010-3W-WH-120/277V	
	Remote mounted unit: FD-010	
Lehigh Electronic Products	Solitaire	PBX
PDM Electrical Products	WPC-5721	
Starfield Controls	TR61 with DALI interface port	RT03 DALInet Router
WattStopper®	LS-4 used with LCD-101 and LCD-103	

LBR4SQ

EXAMPLE

Group Fixture Control*

*Application diagram applies for fixtures with eldoLED drivers only.

nPS 80 EZ Dimming/Control Pack (qty: 2 required)

nPODM 2P DX Dual On/Off/Dim Push-Button WallPod

nCM ADCX Daylight Sensor with Automatic Dimming Control

nCM PDT 9 Dual Technology Occupancy Sensor

Description: This design provides a dual on/off/dim wall station that enables manual control of the fixtures in Row A and Row B separately. Additionally, a daylight harvesting sensor is provided so the lights in Row B can be configured to dim automatically when daylight is available. An occupancy sensor turns off all lights when the space is vacant.

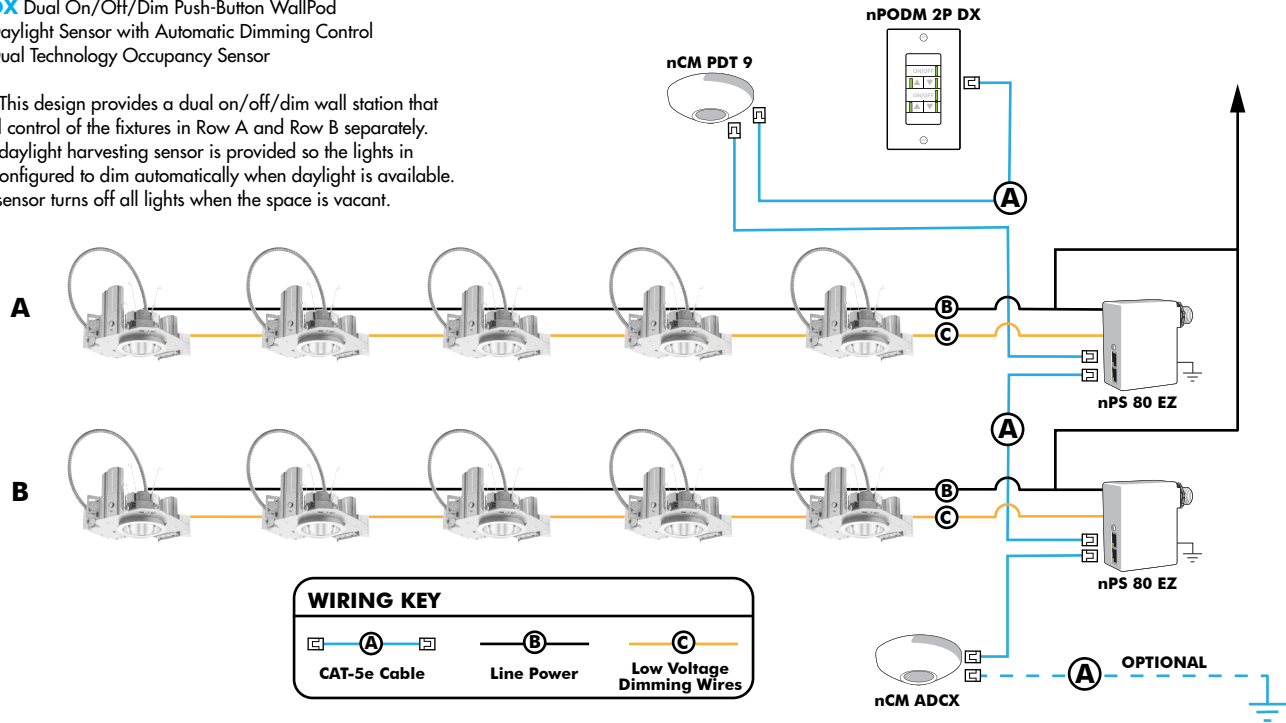

Choose Wall Controls

nLight offers multiple styles of wall controls - each with varying features and user experience.



Push-Button Wallpod
Traditional tactile buttons and LED user feedback



Graphic Wallpod
Full color touch screen provides a sophisticated look and feel

nLight® Wired Controls Accessories:

Order as separate catalog number. Visit www.acuitybrands.com/products/controls/nlight for complete listing of nLight controls.

WallPod Stations	Model number	Occupancy sensors	Model Number
On/Off	nPODM (Color)	Small motion 360°, ceiling (PIR/dual Tech)	nCM 9 / nCM PDT 9
On/Off & Raise/Lower	nPOD DX (Color)	Large motion 360°, ceiling (PIR/dual tech)	nCM 10 / nCM PDT 10
Graphic Touchscreen	nPOD GFX (Color)	Wide View (PIR/dual tech)	nWV 16 / nWV PDT 16
Photocell controls	Model Number	Wall Switch w/ Raise/Lower (PIR/dual tech)	nWSX LV DX / nWSX PDT LV DX
Dimming	nCM ADCX	Cat-5 cables (plenum rated)	Model Number
		10', CAT5 10FT	CATS 10FT J1
		15', CAT5 15FT	CATS 15FT J1

LBR4SQ

nLight® AIR Control Accessories:

Order as separate catalog number. Visit www.acuitybrands.com/products/controls/nlightair.

Wall switches	Model number
On/Off single pole	rPODB [color]
On/Off two pole	rPODB 2P [color]
On/Off & raise/lower single pole	rPODB DX [color]
On/Off & raise/lower two pole	rPODB 2P DX [color]
On/Off & raise/lower single pole	rPODBZ DX WH ¹

Notes

¹ Can only be ordered with the RES7Z zone control sensor version.

UL924 Sequence of Operation

The below information applies to all nLight AIR devices with an EM option.

- EM devices will remain at their high-end trim and ignore wireless lighting control commands, unless a normal-power-sensed (NPS) broadcast is received at least every 8 seconds.
- Using the CLAIRITY+ mobile app, EM devices must be associated with a group that includes a normal power sensing device to receive NPS broadcasts.
- Only non-emergency rPP20, rLSXR, rSBOR, rSDGR, and nLight AIR luminaires with version 3.4 or later firmware can provide normal power sensing for EM devices. See specification sheets for control devices and luminaires for more information on options that support normal power sensing.

nLight AIR

nLight AIR is the ideal solution for retrofit or new construction spaces where adding communication is cost prohibitive. The integrated nLight AIR rPP20 Power Pack is part of each Lithonia LDN Luminaire. These individually addressable controls offer the ultimate in flexibility during initial setup and for space repurposing.

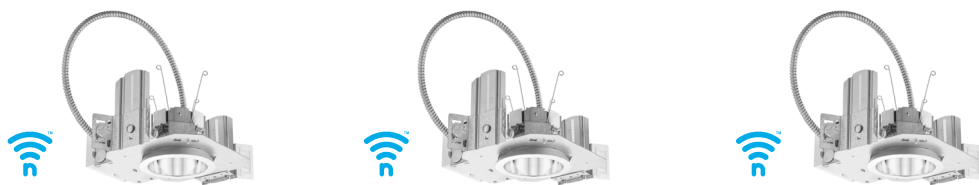

Simple as 1,2,3

1. Install the nLight® AIR fixtures with embedded smart sensor
2. Install the wireless battery-powered wall switch
3. With CLAIRITY app, pair the fixtures with the wall switch and if desired, customize the sensor settings for the desired outcome

